

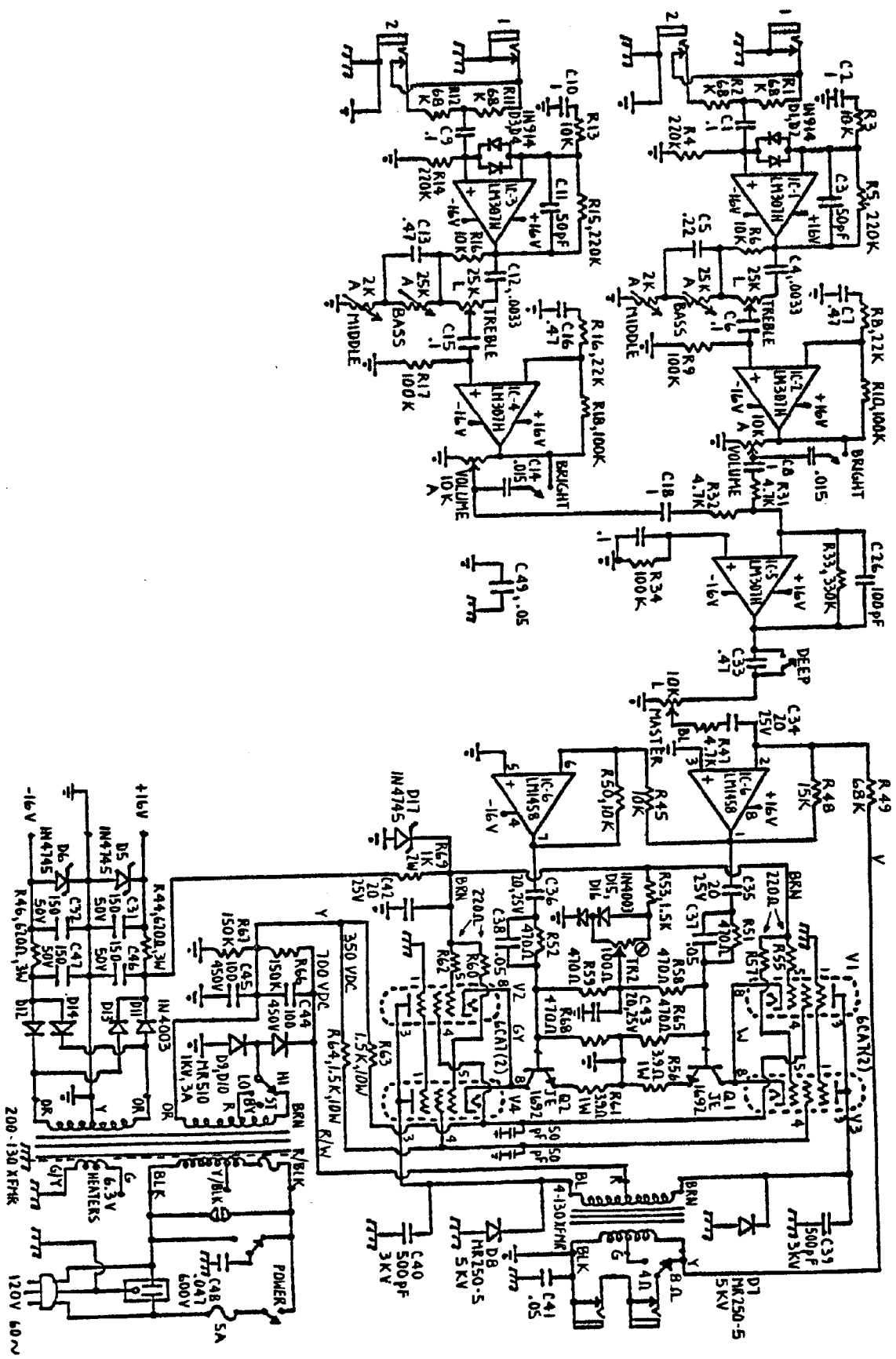

# **Amplifier Schematics**

Chassis Number: 2100-130





CHASSIS № 2100-130

MUSIC MAN INC.  
ANAHEIM, CA.